

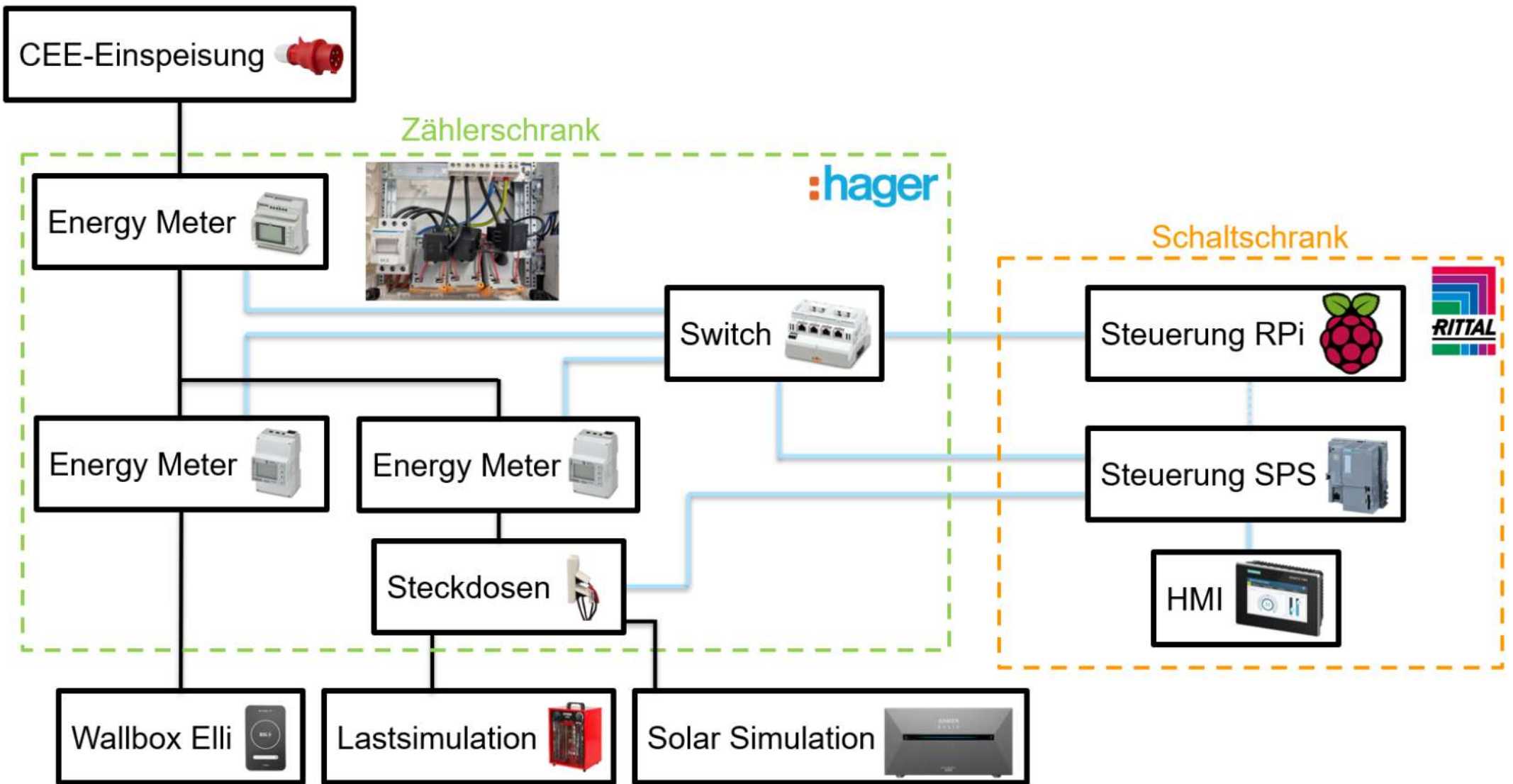

Projektname: GameCharger - ChargeArena
 Projektbeschreibung: Mobiler Lernträger Bidirektionale Wallbox
 Projektverantwortliche: Melina Weinbauer und Tom Neuenfeldt

Firma: BBS 2 Wolfsburg Anschrift: Kleiststr. 44 38440 Wolfsburg Deutschland - Niedersachsen Schule: BBS 2 Wolfsburg Anschrift: Kleiststr. 44 38440 Wolfsburg Deutschland - Niedersachsen	Ersteller: Melina Weinbauer Tom Neuenfeldt	Versetzungsstelle: BBS2 Wolfsburg Endkunde: Stefan Manemann E-Mail: smanemann@bbs2-wolfsburg.de Telefon: +49 (0)5361 261-200 Installationsort: BBS2 Wolfsburg Mobile Station
Erstellt am: 26.03.2026 Zuletzt bearbeitet am: 01.05.2026		
		Anzahl der Seiten: 7

Gesamtübersicht GameCharger - ChargeArena



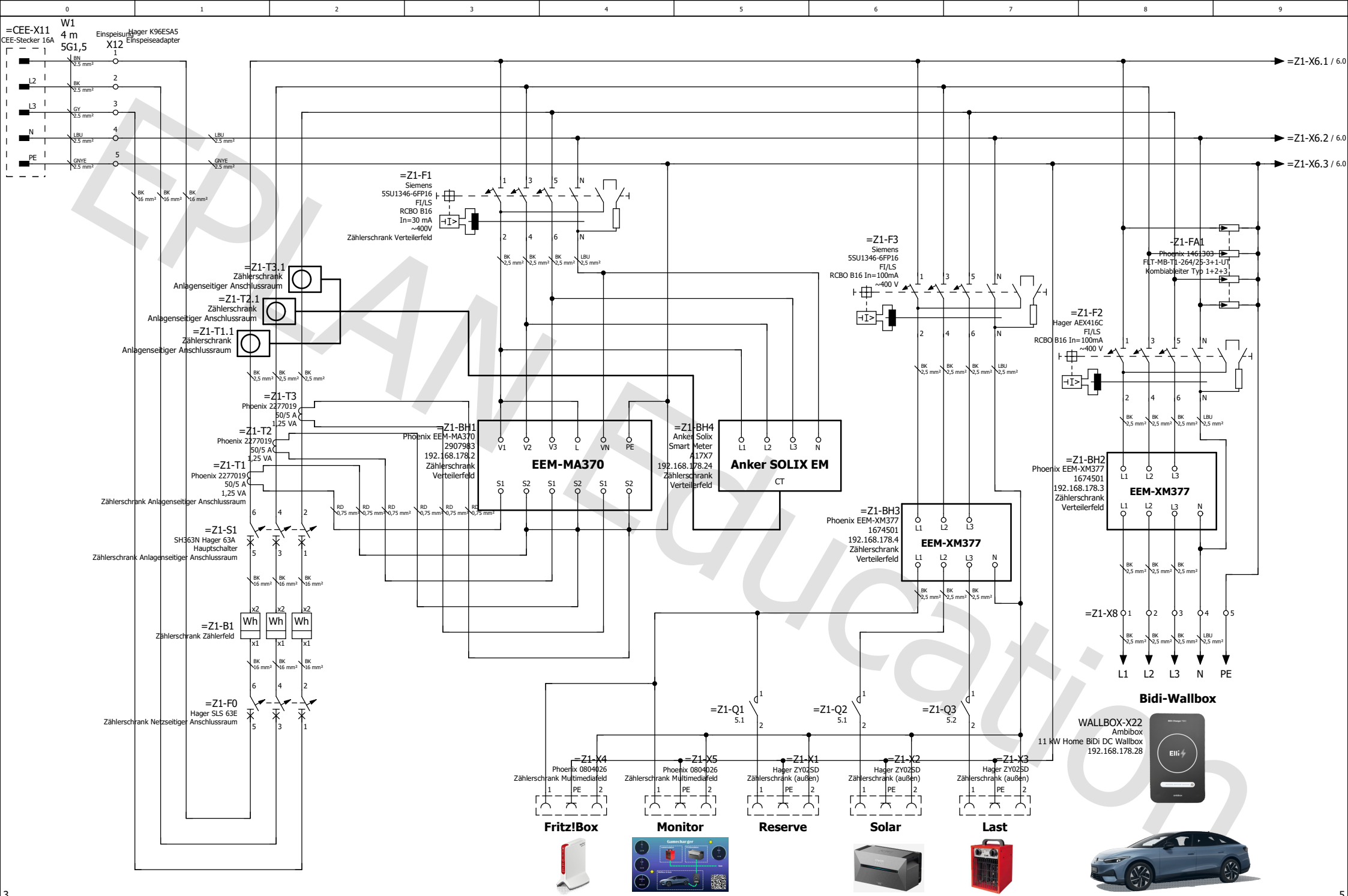

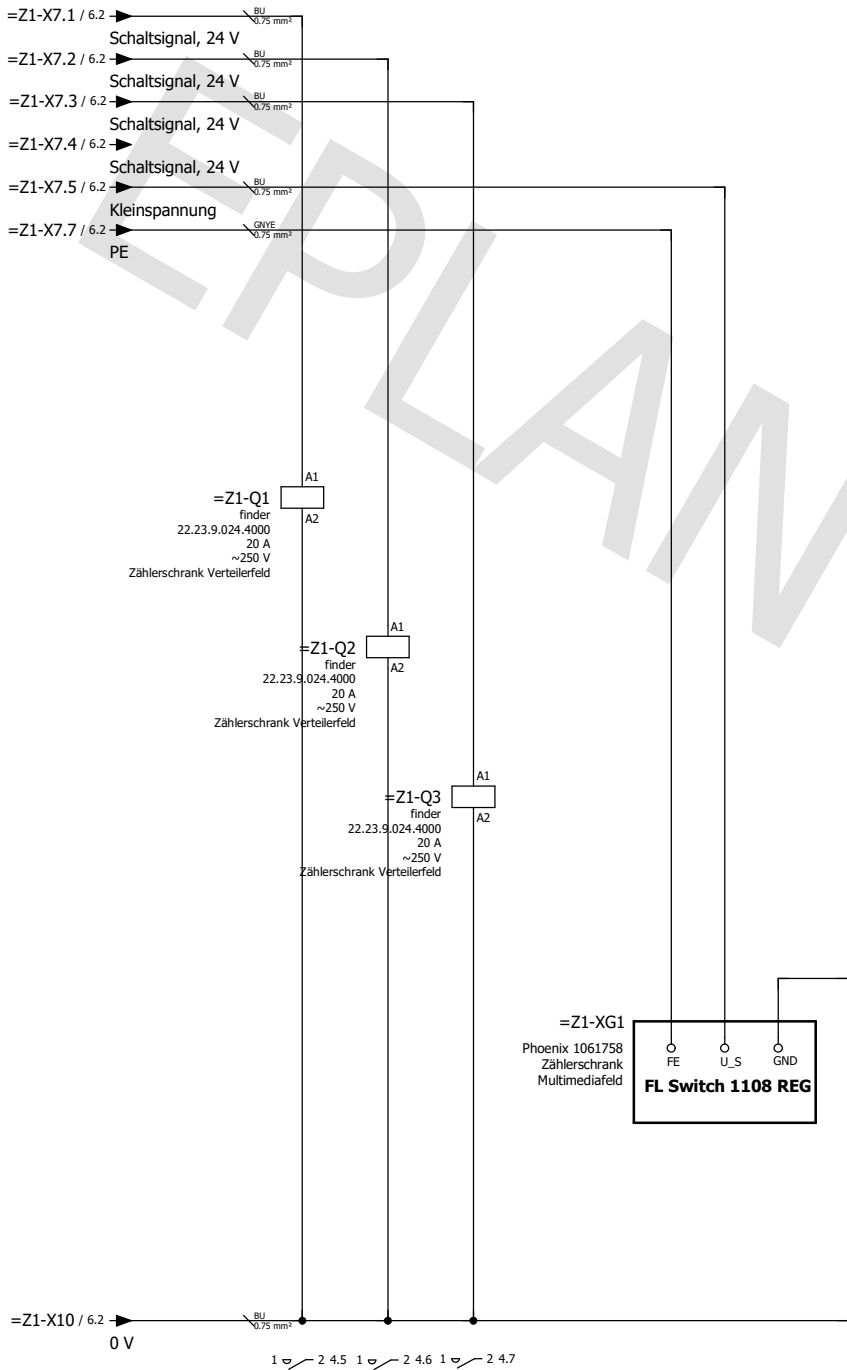

=Z1-XG1
Phoenix 1061758
Zählerschrank
Multimediafeld
FL Switch 1108 REG

1 2 4.5 1 2 4.6 1 2 4.7

			Datum	03.05.2026	EPLAN	BBS 2 Wolfsburg	Hauptverteiler Steuerstromkreis	=
			Bearb.	Schüler*in	Schaltplan BiDi-Lerträger			+
			Gepr.					
Änderung	Datum	Name	Urspr.		Ersatz von	Ersetzt durch		Blatt
								5
								Seite
								5 / 12

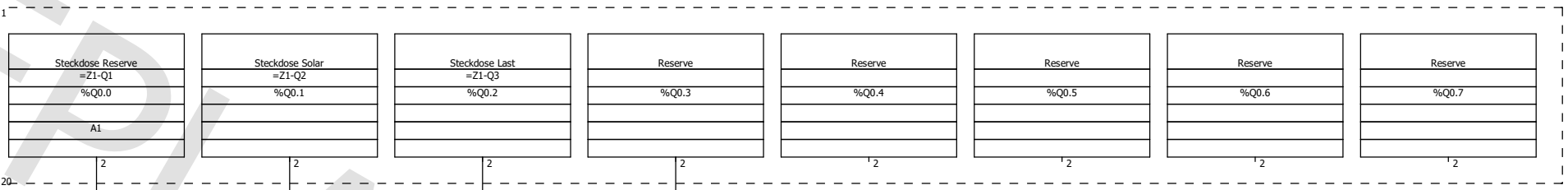
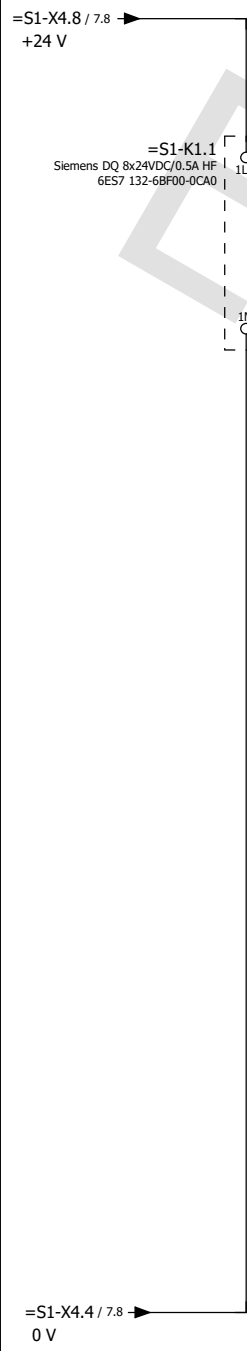

Klemmenplan

Funktionstext	Kabelname	Kabeltyp	Leiste				Kabelname	Kabeltyp	Seite / Spalte
			Zielbezeichnung	Anschluss	Klemme	Brücke			
			=Z1-F1	2	V1			4.3	
				L1					
				L					
			=Z1-F1	4	V2			4.3	
				L2					
			=Z1-F1	6	V3			4.4	
				L3					
				V1	L			4.4	
			=Z1-F1	N	VN			4.4	
				N					
				S2	PE			4.4	
				V1	L1			4.5	
				V2	L2			4.5	
				V3	L3			4.5	
				VN	N			4.6	
			=Z1-T1		S1			4.3	
			=Z1-T1		S2			4.3	
			=Z1-T2		S1			4.4	
			=Z1-T2		S2			4.4	
			=Z1-T3						
			=Z1-T3		S1			4.4	
			=Z1-T3		S2			4.4	
			CEE	5					
			=Z1-X3	PE					
				PE					
			=Z1-Q1	1	L1			4.6	
			=Z1-Q2	1	L2			4.7	
			=Z1-Q3	1	L3			4.7	
			=Z1-X3	2	N			4.7	
			=Z1-F3	6	L3			4.7	
			=Z1-F3	4	L2			4.7	
			=Z1-F3	2	L1			4.6	
			=Z1-F2	2	L1			4.8	
			=Z1-F2	4	L2			4.8	
			=Z1-F2	6	L3			4.8	

Datum	03.05.2026	EPLAN	BBS 2 Wolfsburg	Klemmenplan	=
Bearb.	Schüler*in	Schaltplan BiDi-Lerträger			+
Gepr.					
Änderung	Datum	Name	Urspr.	Ersatz von	Ersetzt durch

EPLAN Electric Catalog

#Z1
Hager Konstruktivtechnik
325667460994

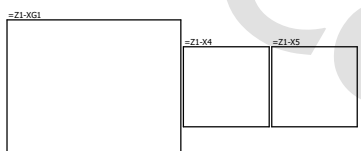
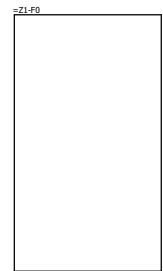
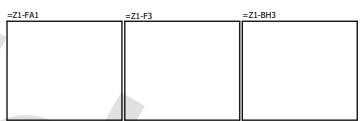
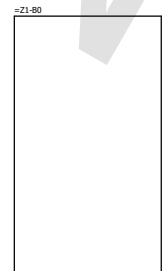
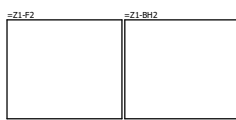
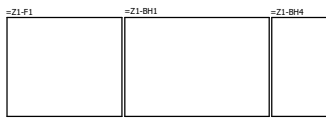
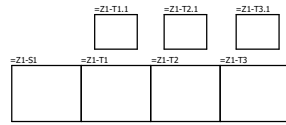

			Datum	03.05.2026	EPLAN	BBS 2 Wolfsburg	Aufbau Zählerschrank	=	
			Bearb.	Schüler*in	Schaltplan BiDi-Lernträger			+	
			Gepr.						Blatt 10
Änderung	Datum	Name	Urspr.		Ersatz von	Ersetzt durch			Seite 11 / 12

